

本体フレーム

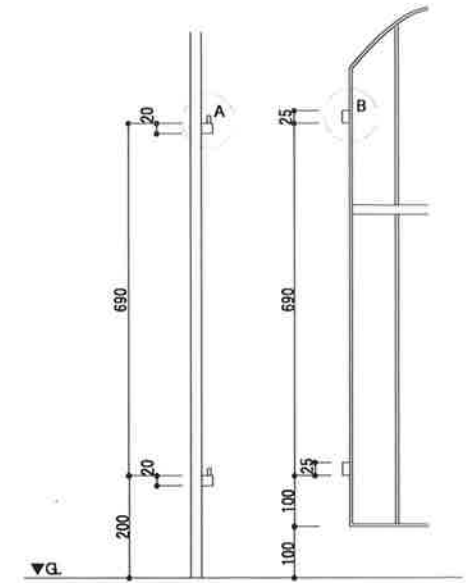
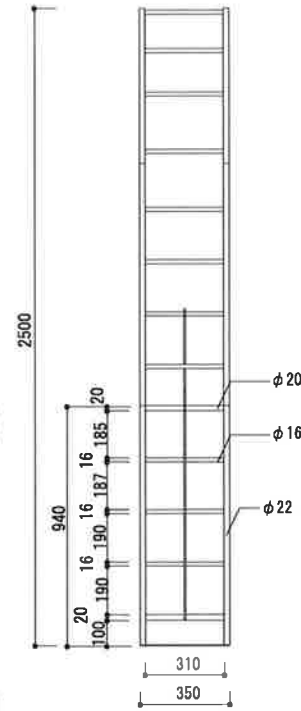
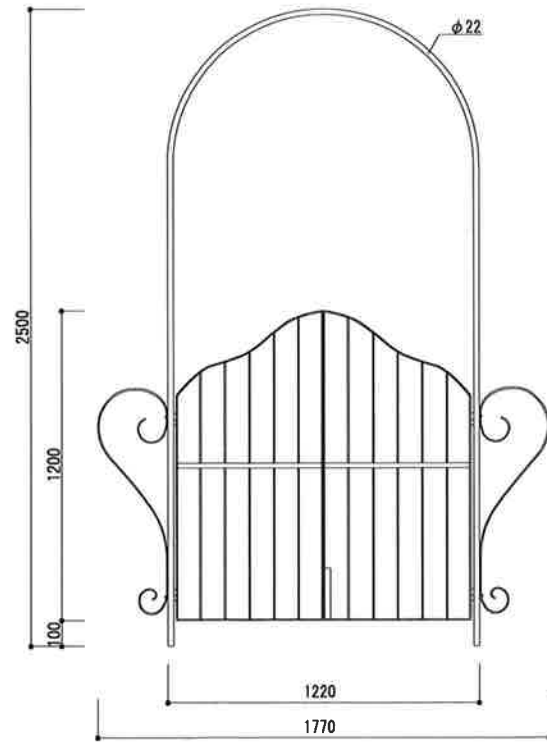
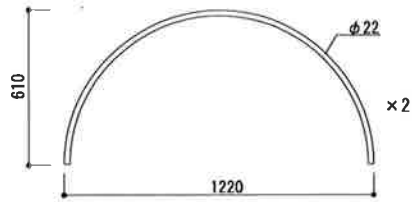
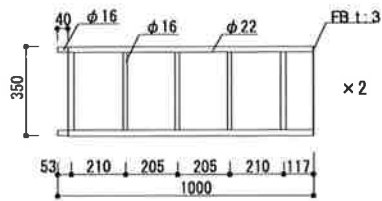
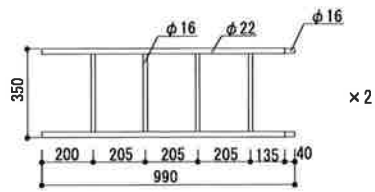
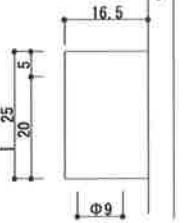
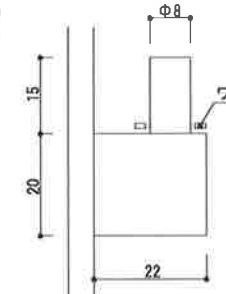

新

| | | | | | | | | | | |
|-------------------|-----|-----|------------------|-------|-------|-------|-------|-------|--------------------|------|
| 設計年月日 29.04.14 | 設計者 | 物件名 | 製図名 門扉付きアーチ1型 | 本社承認印 | 本社承認印 | 本社承認印 | 工場承認印 | 工場承認印 | 縮尺 1/10 1/20 | 製図番号 |
|-------------------|-----|-----|------------------|-------|-------|-------|-------|-------|--------------------|------|